

SENSO



Designer.
Mario Ruiz

STYLE. ESTILO.
Singular

COLLECTION. COLECCIÓN
Senso

VERSION. VERSIÓN.
Low arm version. Version à bras bas. Versión de brazo bajo. (55 cm - 21.65 in)

Features. Traits. Características.

FIXED VERSION FEATURES.

Removable upholstery in seat, back and auxiliary cushions.

Wooden frame covered with foam and fibre.

Seat cushions in different polyurethane foam densities, with surface padding in fibre. Back cushions stuffed with polyester fibre and washed, sterilised down.

Metal bases coated in epoxy paint with a manganese topcoat and LDPE stops.

REMOVABLE COVER VERSION FEATURES.

Completely removable upholstery. In leather, seat, back and auxiliary cushions with removable covers.

TRAITS VERSION FIXE.

Tapiserie déhoussable sur les coussins de l'assise, coussins du dossier et coussins auxiliaires.

Châssis en bois recouvert de mousse et fibre.

Coussins de l'assise réalisés dans différentes densités de mousse polyuréthane, matelassés en surface avec du fibre. Coussins du dossier garnis de fibre de polyester et plumes lavées et stérilisées.

Bases métalliques en peinture époxy finition manganèse avec butées en PEBD.

TRAITS VERSION DÉHOUSSABLE.

Tapiserie entièrement déhoussable. En cuir, coussins de l'assise, du dossier et auxiliaires déhoussables.

CARACTERÍSTICAS VERSIÓN FIJO.

Tapicería desenfundable en cojines de asiento, cojines de respaldo y cojines auxiliares.

Bastidor de madera recubierto de espuma y fibra.

Cojines de asiento realizados es distintas densidades de espuma de poliuretano, acolchado en la superficie con fibra. Cojines de respaldo rellenos de fibra de poliéster y pluma lavada y esterilizada.

Bases metálicas en pintura epoxi acabado manganeso con topes de LDPE.

CARACTERÍSTICAS VERSIÓN DES-ENFUNDABLE.

Tapicería totalmente desenfundable. En piel, cojines de asiento, respaldos y auxiliares desenfundables.

SENSO

LOW ARM VERSION. VERSION À BRAS BAS. VERSIÓN DE BRAZO BAJO.

SOFAS. CANAPÉS. SOFÁS.

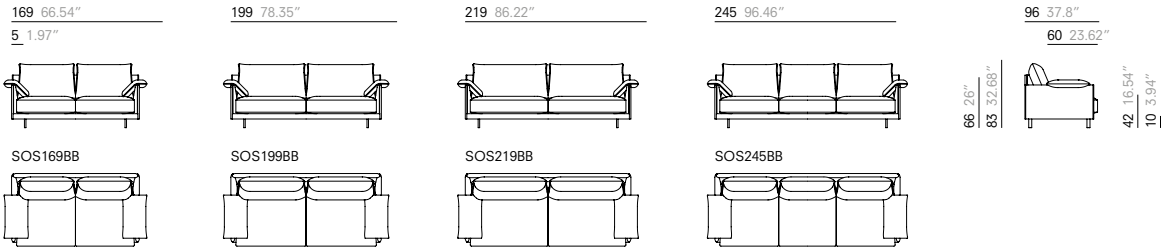

Measurement. Mesure. Medida.	REF.
169 66.54"	SOS169BB
199 78.35"	SOS199BB
219 86.22"	SOS219BB
245 96.46"	SOS245BB

ARMCHAIRS. FAUTEILS. BUTACAS.

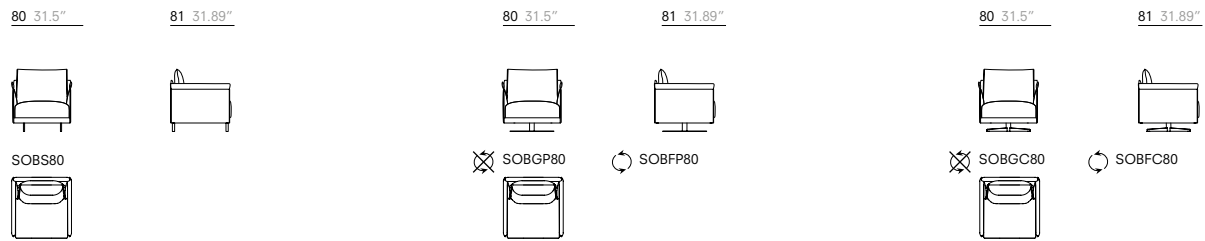

Standard metal bases. Bases métalliques standard.
Bases metálicas standard.

Flat fixed or rotating with autoreturn flat metal base.
Base fixe o pivotante avec retour automatique métallique avec socle plat.
Base fija o giratoria con retorno metálica plana.

Cross-shaped fixed or rotating with autoreturn metal base.
Base fixe o pivotante avec retour automatique en croix.
Base fija o giratoria con retorno metálica en cruz.

Measurement. Mesure. Medida.	BASE	REF.
80 31.5"	Base standard. Base éstandard	SOBS80
80 31.5"	Flat fixed. Plat fixé. Plana fija.	SOBFP80
80 31.5"	Cross fixed. Croix fixé. Cruz fija.	SOBFC80
80 31.5"	Flat rotating. Pivotante plat. Giratoria plana.	SOBGP80
80 31.5"	Cross rotating. Croix pivotante. Giratoria cruz.	SOBGC80

HIGH BACKREST. DOSSIER HAUT. RESPALDO ALTO.

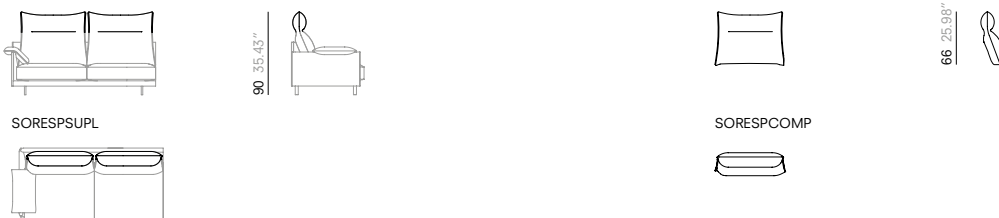

Measurement. Mesure. Medida.	REF.
	SORESPSUPL
	SORESPCOMP

SENSO SYSTEM

LOW ARM VERSION. VERSION À BRAS BAS. VERSIÓN DE BRAZO BAJO.

SOFAS WITH 1 ARM. CANAPÉS AVEC 1 ACCOUDOIR. SOFÁS CON 1 BRAZO.

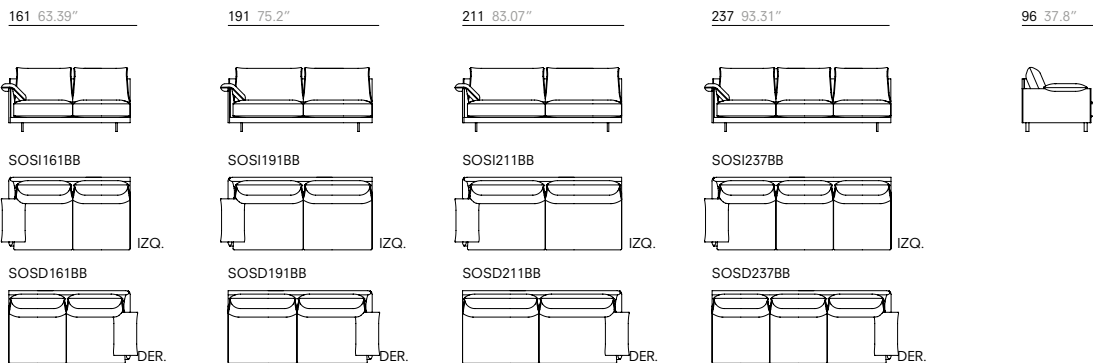

Measurement. Mesure. Medida.	REF. IZQ.	REF. DER.
161 63.39"	SOSI161BB	SOSD161BB
191 75.2"	SOSI191BB	SOSD191BB
211 83.07"	SOSI211BB	SOSD211BB
237 93.31"	SOSI237BB	SOSD237BB

SOFAS WITHOUT ARMS. CANAPÉS SANS ACCOUDOIRS. SOFÁS SIN BRAZOS.

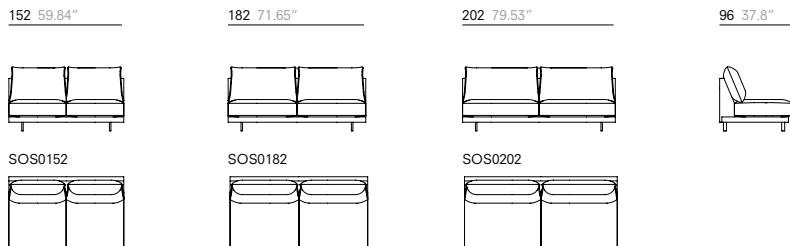

Measurement. Mesure. Medida.	REF.
152 59.84"	SOS0152
182 71.65"	SOS0182
202 79.53"	SOS0202

CORNERS. ANGLES. RINCONES.

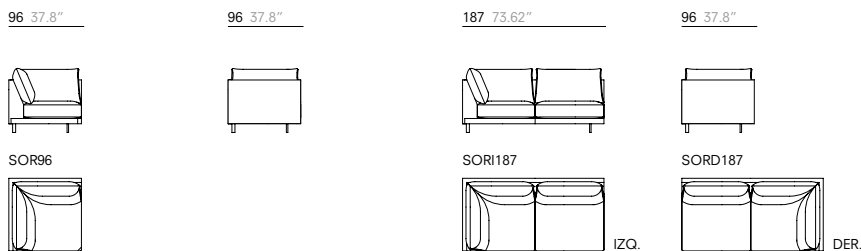

Measurement. Mesure. Medida.	REF. IZQ.	REF. DER.
96 37.8"	SOR96	SOR96
187 73.62"	SOR187	SORD187

SENSO SYSTEM

LOW ARM VERSION. VERSION À BRAS BAS. VERSIÓN DE BRAZO BAJO.

CHAISE LONGUE.

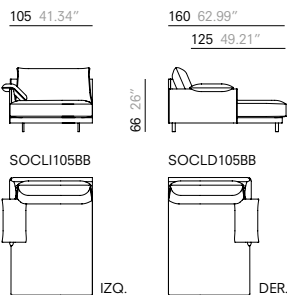

Measurement. Mesure. Medida.	REF. IZQ.	REF. DER.
105 41.34"	SOCLI105BB	SOCLD105BB

OTTOMANS. POUFS. OTTOMANS.

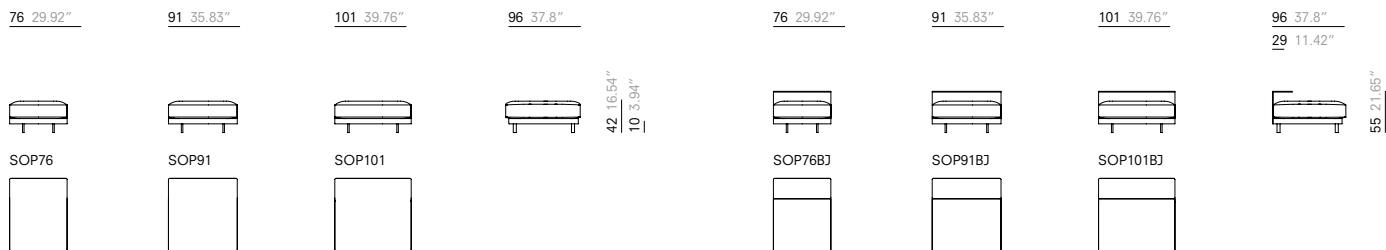

Measurement. Mesure. Medida.	REF.
76 29.92"	SOP76
91 35.83"	SOP91
101 39.76"	SOP101

Measurement. Mesure. Medida.	With tray. Avec plateau. Con bandeja.
76 29.92"	SOP76BJ
91 35.83"	SOP91BJ
101 39.76"	SOP101BJ

SENSO



Designer.
Mario Ruiz

STYLE. ESTILO.
Singular

COLLECTION. COLECCIÓN
Senso

VERSION. VERSIÓN.
High arm version. Version à bras haut. Versión de brazo alto. (66 cm - 26 in.)

Features. Traits. Características.

FIXED VERSION FEATURES.

Removable upholstery in seat, back and auxiliary cushions.

Wooden frame covered with foam and fibre.

Seat cushions in different polyurethane foam densities, with surface padding in fibre. Back cushions stuffed with polyester fibre and washed, sterilised down.

Metal bases coated in epoxy paint with a manganese topcoat and LDPE stops.

REMOVABLE COVER VERSION FEATURES.

Completely removable upholstery. In leather, seat, back and auxiliary cushions with removable covers.

TRAITS VERSION FIXE.

Tapiserie déhoussable sur les coussins de l'assise, coussins du dossier et coussins auxiliaires.

Châssis en bois recouvert de mousse et fibre.

Coussins de l'assise réalisés dans différentes densités de mousse polyuréthane, matelassés en surface avec du fibre. Coussins du dossier garnis de fibre de polyester et plumes lavées et stérilisées.

Bases métalliques en peinture époxy finition manganèse avec butées en PEBD.

TRAITS VERSION DÉHOUSSABLE.

Tapiserie entièrement déhoussable. En cuir, coussins de l'assise, du dossier et auxiliaires déhoussables.

CARACTERÍSTICAS VERSIÓN FIJO.

Tapicería desenfundable en cojines de asiento, cojines de respaldo y cojines auxiliares.

Bastidor de madera recubierto de espuma y fibra.

Cojines de asiento realizados es distintas densidades de espuma de poliuretano, acolchado en la superficie con fibra. Cojines de respaldo rellenos de fibra de poliéster y pluma lavada y esterilizada.

Bases metálicas en pintura epoxi acabado manganeso con topes de LDPE.

CARACTERÍSTICAS VERSIÓN DES-ENFUNDABLE.

Tapicería totalmente desenfundable. En piel, cojines de asiento, respaldos y auxiliares desenfundables.

SENSO

HIGH ARM VERSION. VERSION À BRAS HAUT. VERSIÓN DE BRAZO ALTO.

SOFAS. CANAPÉS. SOFÁS.

169 66.54"
5 1.97"

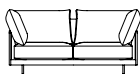

SOS169BA

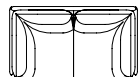

199 78.35"

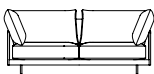

SOS199BA

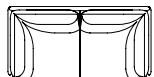

219 86.22"

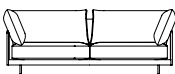

SOS219BA

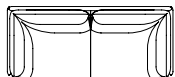

245 96.46"

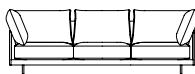

SOS245BA

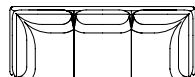

96 37.8"
60 23.62"
66 26"
83 32.68"
42 16.54"
10 3.94"

Measurement.
Mesure. Medida.

REF.

169 66.54" SOS169BA

199 78.35" SOS199BA

219 86.22" SOS219BA

245 96.46" SOS245BA

SENSO SYSTEM

HIGH ARM VERSION. VERSION À BRAS HAUT. VERSIÓN DE BRAZO ALTO.

SOFAS WITH 1 ARM. CANAPÉS AVEC 1 ACCOUDOIR. SOFÁS CON 1 BRAZO.

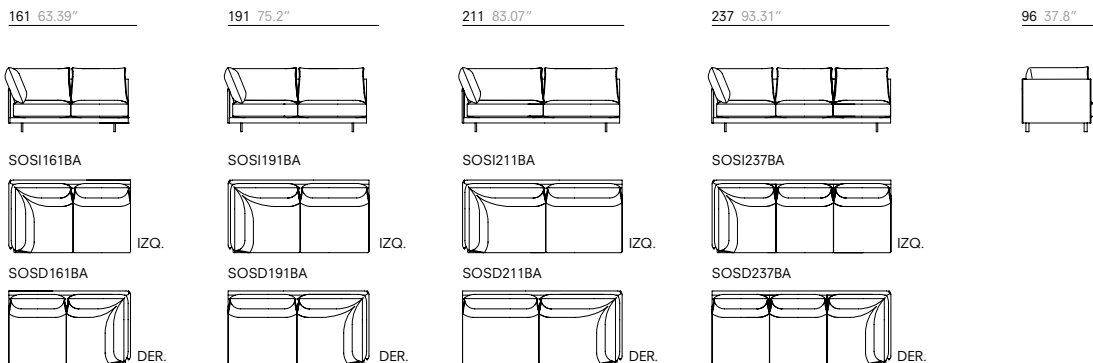

Measurement. Mesure. Medida.	REF. IZQ.	REF. DER.
161 63.39"	SOSI161BA	SOSD161BA
191 75.2"	SOSI191BA	SOSD191BA
211 83.07"	SOSI211BA	SOSD211BA
237 93.31"	SOSI237BA	SOSD237BA

SOFAS WITHOUT ARMS. CANAPÉS SANS ACCOUDOIRS. SOFÁS SIN BRAZOS.

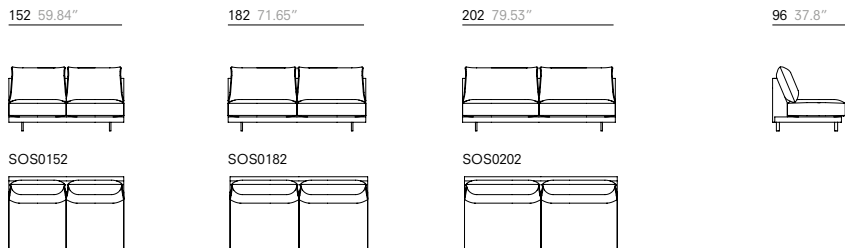

Measurement. Mesure. Medida.	REF.
152 59.84"	SOS0152
182 71.65"	SOS0182
202 79.53"	SOS0202

CORNERS. ANGLES. RINCONES.

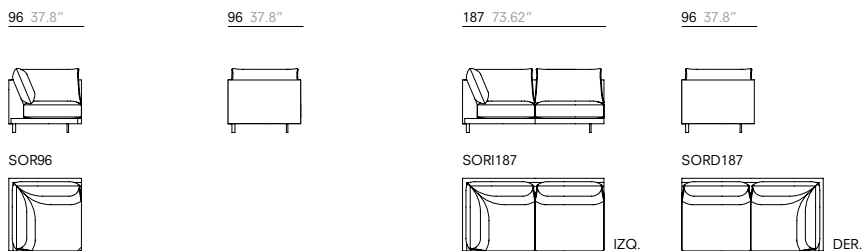

Measurement. Mesure. Medida.	REF. IZQ.	REF. DER.
96 37.8"	SOR96	SOR96
187 73.62"	SOR187	SORD187

SENSO SYSTEM

HIGH ARM VERSION. VERSION À BRAS HAUT. VERSIÓN DE BRAZO ALTO.

CHAISE LONGUE.

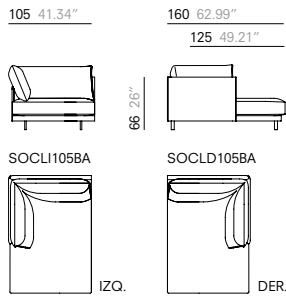

Measurement. Mesure. Medida.	REF. IZQ.	REF. DER.
105 41.34"	SOCLI105BA	SOCLD105BA

OTTOMANS. POUFS. OTTOMANS.

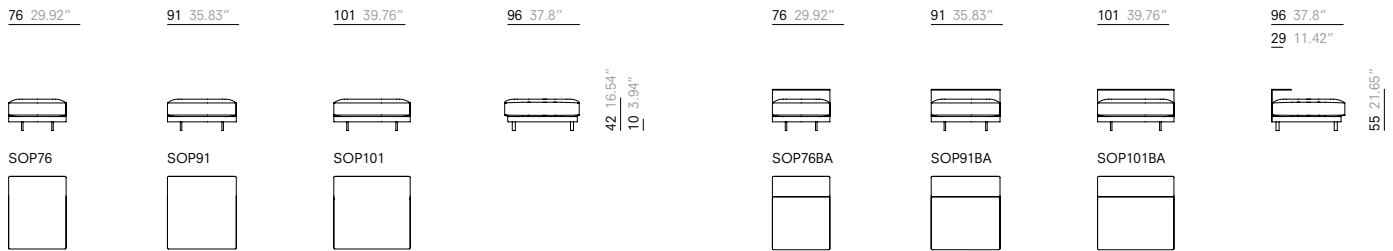

With tray. Avec plateau. Con bandeja.

Measurement. Mesure. Medida.	REF.
76 29.92"	SOP76
91 35.83"	SOP91
101 39.76"	SOP101

Measurement. Mesure. Medida.	With tray. Avec plateau. Con bandeja.
76 29.92"	SOP76BJ
91 35.83"	SOP91BJ
101 39.76"	SOP101BJ



spencer interiors
 vancouver bc canada
 telephone: 604.736.1378
 www.spencerinteriors.ca